

# ORIMA®

## 2020 PRODUKTŲ KATALOGAS Baltia



**ORIMA®**  
The Finnish Quality  
Since 1960

VANDENS NUTEKĖJIMO SISTEMOS .....	4
P13, P87, P10.....	4
K12, K9x9 .....	6
P10.....	8
Techninė informacija .....	9
SIENINĖS KOPĖČIOS.....	10
AVARINĖS KOPĖČIOS .....	12
LAIPTAI.....	13
STOGO KOPĖČIOS .....	14
STOGO TILTELIAI.....	16
SNIEGO SULAIKYMAS .....	18
GROTŲ SNIEGO SULAIKYMAS .....	20
STOGO ATITVARAI.....	21
BĖGIS.....	22



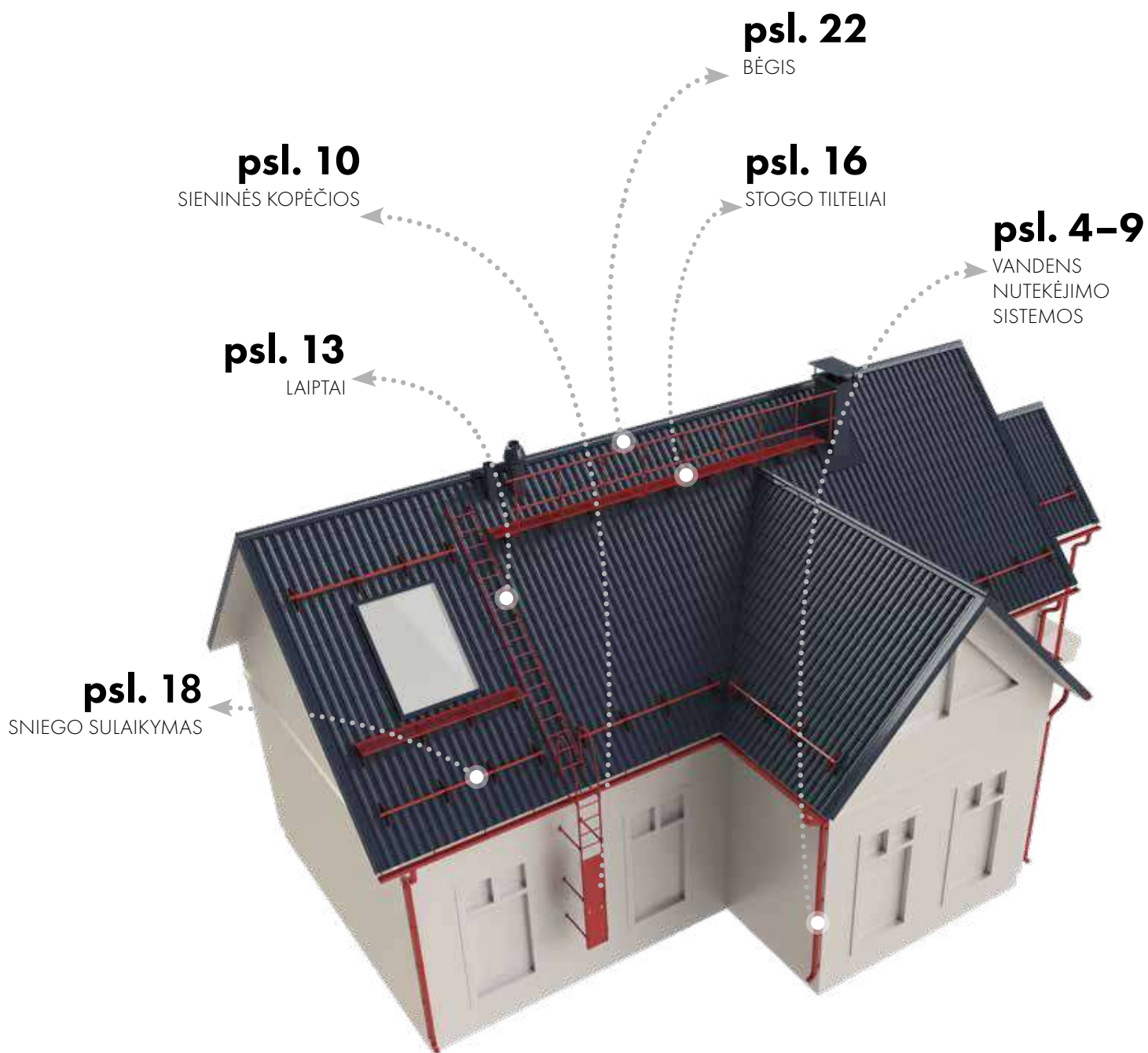

METALO ČĒRPĒS    PROFKLOJINYS    MINKŠTAS STOGAS    JUNGTTINIS STOGAS    NATŪRALIOS ČĒRPĒS    ETERNIT    CEMBRIT

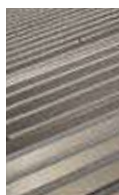
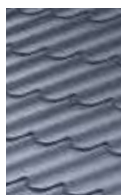

# VANDENS NUTEKĖJIMO SISTEMOS

P13, P87, P10











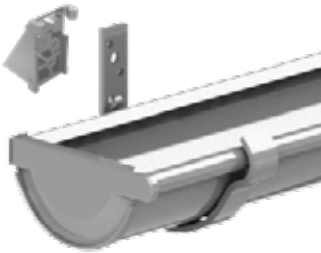



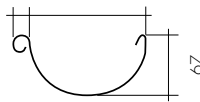

\*Standartinės spalvos: RR20 Balta RR23 Tamsiai pilka RR32 Tamsiai ruda RR33 Juoda



Nestandartinės spalvos +20 % (pagal užklausą) RR11 Tamsiai žalia RR21 Šviesiai pilka RR22 Pilka RR29 Tamsiai raudona RR750 Plytų raudona

Metalo blizgesio turinčios spalvos +30 %: RR41

Nestandartinis ilgis +10 %

PRODUKTAS	KODAS	PRISTATYMO LAIKAS	APIBŪDINIMAS		
<b>P13 LATAKAS</b> 	3 m 	10150	5		
	4 m 	10170	5		
	5 m 	10010	5		
	6 m 	10020	5		
	P13 LATAKAS			16 125 	
	P13 LATAKO KABLYS, REGULIUOJAMAS	10730	5	1 m	
	P13 LATAKO KABLYS TRUMPAS	10110	5	1 m	
	UODEGĖLĖS KOMPENSATORIUS	1:4 	10580	5	
		1:3 	10590	5	
		1:2 	10600	5	
		1:1,5 	10610	5	
	P13 LATAKO KABLYS	1:2,5 	10160	5	1 m
	P13 LATAKO KABLYS	1:3 	10130	5	1 m
	P13/K12 UŽPAKALINĖ KABLIO DALIS (K FORMOS)	11150	5		
	P13 LATAKO KABLYS ILGAS	10120	5	1 m	
	P13/K12 KABLIO ILGINTUVAS	11140	5		
	P13 LATAKO DANGTIS (SU SANDARINIMU)	10040	5		
	P13 KABLIO SUJUNGĖJAS	10050	5		
	P13 LATAKO DANGTIS (SU SANDARINIMU)	10060	5		
	P13 VIDINIS KAMPAS	10070	5		
	P13 IŠORINIS KAMPAS	10080	5		

PRODUKTAS	KODAS	PRISTATYMO LAIKAS	APIBŪDINIMAS	
<b>P87 NUTEKAMASIS VAMZDIS</b> 	P13/P87 LATAKO PILTUVAS	13500	5	
	P87 NUTEKAMASIS VAMZDIS	1,0 m 	13530	5
		2,5 m 	13540	5
	P87 ALKŪNĖ	13520	5	
	P87 NUTEKAMOJO VAMZDŽIO TVIRTINIMAS	13560	5	1,5 m
	P87 PILTUVAS VANDENS SURINKIMUI	13610	5	
	P87 TRIŠAKIS	13620	10	
	P87 NUVEDIMAS VANDENS SURINKIMUI	13670	10	

PRODUKTAS	KODAS	PRISTATYMO LAIKAS	APIBŪDINIMAS	
<b>P10 NUTEKAMASIS VAMZDIS</b> 	P13/P10 LATAKO PILTUVAS	10090	5	
	P10 NUTEKAMASIS VAMZDIS	1,0 m 	13010	5
		2,3 m 	13020	5
	P10 ALKŪNĖ	13180	5	
	P10 NUTEKĖJIMO VAMZDIS	13190	5	
	K9*9/P10 NUTEKAMOJO VAMZDŽIO TVIRTINIMAS	13050	5	= KODAS 13040 + 12040. 1,5 m
		13040	5	
		12040	5	
	P10 NUTEKAMOJO VAMZDŽIO TVIRTINIMAS M2000	13030	5	1,5 m
	P10 PILTUVAS VANDENIUI RINKTI	13140	10	
P10 NUVEDIMAS VANDENS SURINKIMUI	13660	10		
P10 TRIŠAKIS	13680	10		

PRODUKTAS	KODAS	PRISTATYMO LAIKAS	APIBŪDINIMAS	
<b>NUTEKĖJIMO VAMZDŽIAI SU APSAUGA NUO VANDALŲ</b> 	VAMZDIS SU APSAUGA NUO VANDALŲ 108 mm, TIESUS	2,0 m 	15010	10
	VAMZDIS SU APSAUGA NUO VANDALŲ 108 mm	2,0 m 	15020	10
	ANTIVANDALINIO VAMZDŽIO TVIRTINIMAS 108 mm	15030	10	

# VANDENS NUTEKĖJIMO SISTEMOS

K12, K9x9

















\*Standartinės spalvos: RR20 Balta RR23 Tamsiai pilka RR32 Tamsiai ruda RR33 Juoda

Nestandartinės spalvos +20 % (pagal užklausą) RR11 Tamsiai žalia RR21 Šviesiai pilka RR22 Pilka RR29 Tamsiai raudona RR750 Plytų raudona

Metalo blizgesio turinčios spalvos +30 %: RR41

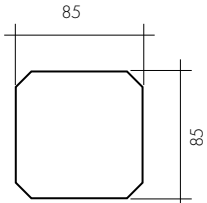
Nestandartinis ilgis +10 %

PRODUKTAS	DIMENSIJA	KODAS	PRISTATYMO LAIKAS	APIBŪDINIMAS	
<b>K12 LATAKAS</b> 	3 m 	11170	5		
	K12 LATAKAS	4 m 	11260		5
		5 m 	11010		5
		6 m 	11020		5
	K12 LATAKO KABLYS		11110	5	1 m
	UODEGĖLĖS KOMPENSATORIUS	1:4 	10580	5	
		1:3 	10590	5	
		1:2 	10600	5	
		1:1,5 	10610	5	
	K12 LATAKO KABLYS 1:2,5	1:2,5 	11180	5	1 m
	K12 LATAKO KABLYS 1:3	1:3 	11120	5	1 m
	P13/K12 UŽPAKALINĖ KABLIŲ DALIS (K FORMOS)		11150	5	1 m
	K12 VIDINIS KRONŠTEINAS		11130	5	1 m, galv.
	P13/K12 KABLIŲ ILGINTUVAS		11140	5	
	K12 LATAKO SKLENDĖ DEŠINĖ		11040	5	
	K12 LATAKO SKLENDĖ KAIRĖ		11050	5	
	K12 VIDINIS KAMPAS		11070	5	
	K12 IŠORINIS KAMPAS		11080	5	





PRODUKTAS	DIMENSIJA	KODAS	PRISTATYMO LAIKAS	APIBŪDINIMAS	
<b>K9*9 NUTEKAMASIS VAMZDIS</b> 	K12 LATAKO PILTUVAS	11090	5		
	K9*9 NUTEKAMASIS VAMZDIS	1,0 m 	12010		5
		2,0 m 	12020		5
	K9*9 NUTEKĖJIMO VAMZDIS 2,6 m	2,6 m 	12030		5
	K9*9 VIRŠUTINĖ ALKŪNĖ		12080	5	
	K9*9 APATINĖ ALKŪNĖ		12090	5	
	K9*9 NUTEK. VAMZDŽIO TVIRTINIMAS M2000		12070	5	1,5 m
	K9*9/P10 NUTEKAMOJO VAMZDŽIO TVIRTINIMAS		13050	5	= KODAS 13040 + 12040. 1,5 m
			13040	5	
			12040	5	
	K12 NUTEKĖJIMO PILTUVAS		11100	5	
	K9*9 NUVEDIMAS 5 cm		12100	10	
	K9*9 NUVEDIMAS 10 cm		12110	10	
	K9*9 NUVEDIMAS 20 cm		12120	10	
K9*9 NUVEDIMAS 15 cm		12130	10		
K9*9 NUVEDIMAS VANDENS SURINKIMUI		12170	10		
K9*9 UŽSAKYTO DYDŽIO ALKŪNĖ		12970	10		

**NUTEKĖJIMO VAMZDŽIAI SU APSAUGA NUO VANDALŲ**

	K9*9 VAMZDIS SU APSAUGA NUO VANDALŲ 2 m	2,0 m 	12150	10	
	K9*9 ANTIVANDALINIO VAMZDŽIO TVIRTINIMAS		12160	10	

# VANDENS NUTEKĖJIMO SISTEMOS

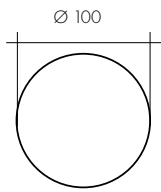
## P10

PRODUKTAS	DIMENSIJA	KODAS	PRISTATYMO LAIKAS		APIBŪDINIMAS
<b>P10 NUTEKAMASIS VAMZDIS</b>					
	1,0 m 	13010	5		
	P10 NUTEKAMASIS VAMZDIS				
	2,3 m 	13020	5		
	P10 VIRŠUTINĖ ALKŪNĖ	13070	5		
	P10 APATINĖ ALKŪNĖ	13080	5		
	P10 NUTEKĖJIMO VAMZDIS	13090	5		
	P10 NUTEKAMOJO VAMZDŽIO TVIRTINIMAS M2000	13030	5		1,5 m
	K9*9/P10 NUTEKAMOJO VAMZDŽIO TVIRTINIMAS	13050	5		= KODAS 13040 + 12040. 1,5 m
		13040	5		
		12040	5		
	P13 KAKLELIS TRUMPAS	10100	10		
	P10 NUVEDIMAS 5 cm	13100	10		
	P10 NUVEDIMAS 10 cm	13110	10		
	P10 NUVEDIMAS 15 cm	13120	10		
	P10 NUVEDIMAS 20 cm	13130	10		
	P10 UŽSAKYTO DYDŽIO ALKŪNĖ	13650	10		

PRODUKTAS	DIMENSIJA	KODAS	PRISTATYMO LAIKAS		APIBŪDINIMAS
<b>Plieno ritiniai</b>					
RR20, -23, -32, -33	Plotis 300 mm	55530	5		
NESTANDARTINĖS SPALVOS	Plotis 300 mm	56030	10		

\*Standartinės spalvos: **RR20** Baltas **RR23** Tamsiai pilkas **RR32** Tamsiai rudas **RR33** Juodas

Nestandartinės spalvos +20 % (pagal užklausą): **RR11** Tamsiai žalia **RR21** Šviesiai pilkas **RR22** Pilkas **RR29** Tamsiai raudonas **RR750** Plytų raudonas

Metalo blizgesio turinčios spalvos +30 %: **RR41**





Nestandartinis ilgis +10 %

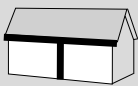
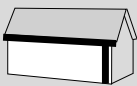
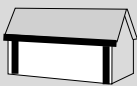

# VANDENS NUTEKĖJIMO SISTEMOS

## Techninė informacija

### ŠLAITO PLOTAS IR NUTEKAMŲJŲ VAMZDŽIŲ IŠDĖSTYMAS

NUTEKAMŲJŲ VAMZDŽIŲ KIEKIS IR IŠDĖSTYMAS	ŠLAITO PLOTAS IR NUTEKAMŲJŲ VAMZDŽIŲ IŠDĖSTYMAS		
			
P87 	150 m <sup>2</sup>	100 m <sup>2</sup>	200 m <sup>2</sup>
P10 	225 m <sup>2</sup>	150 m <sup>2</sup>	300 m <sup>2</sup>
K9x9 	190 m <sup>2</sup>	130 m <sup>2</sup>	250 m <sup>2</sup>

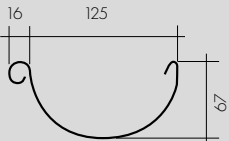
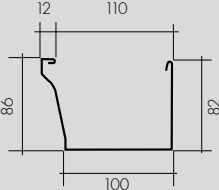
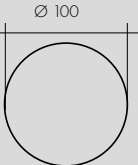
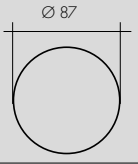
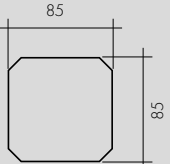
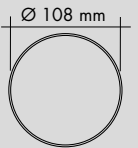
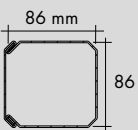

### SUDERINAMUMAS

NUTEKAMASIS VAMZDIS	LATAKAS	
	P13 	K12 
P10 	X	
P87 	X	X
K9x9 		X
Vamzdis su apsauga nuo vandalų 	X	
Vamzdis su apsauga nuo vandalų 		X

# SIENINĖS KOPĖČIOS

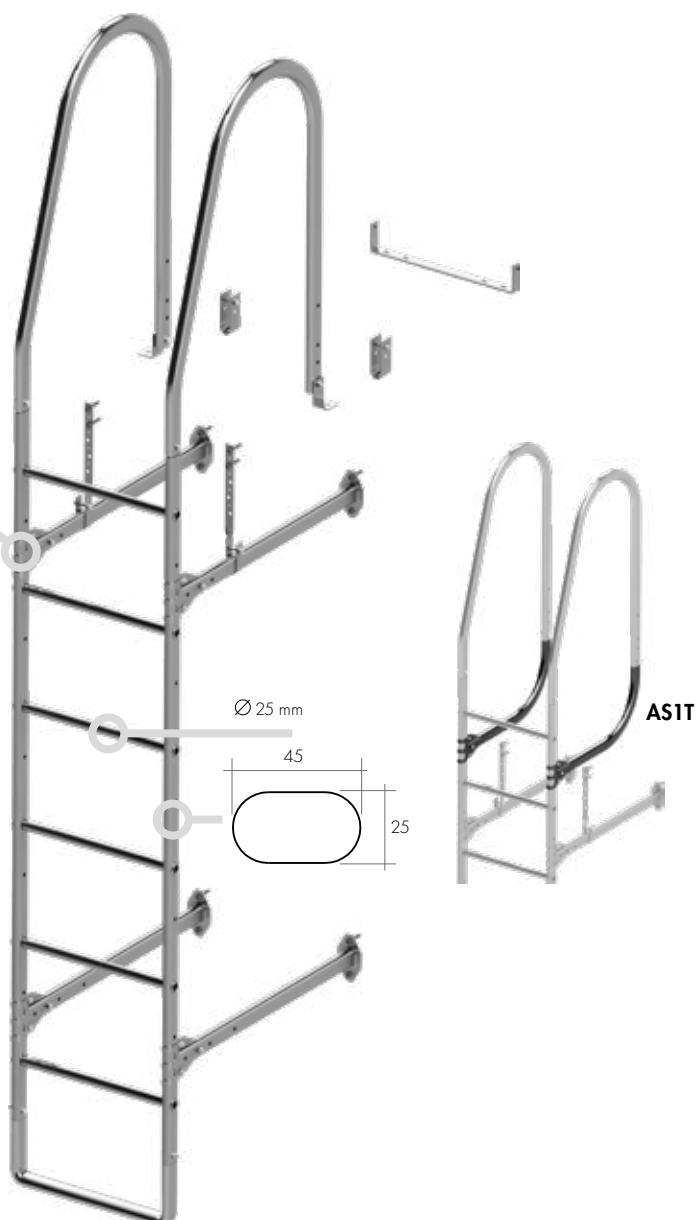
SUJUNGIAMASIS  
ANTDĒKLAS  
20290

























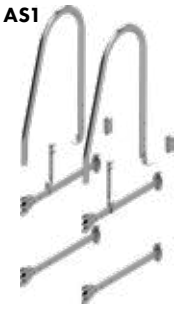





PRODUKTAS	KODAS	PRISTATĀMO LAIKAS	KOPĒČIŅU ILGIS					
			5,4 m	6 m	6,6 m	7,5 m	8,4 m	
<b>KOPĒČIŅU MODULIJA</b>	1,2 m	21120	5					
	2,7 m	20040	5	2 vnt.	1 vnt.			
	3,3 m	21130	5		1 vnt.	2 vnt.	1 vnt.	
	4,2 m	20070	5				1 vnt.	2 vnt.
	PLASTMASINĒ SKLENDĒ OVALI.	20150	5					

\*Standartinĕs spalvas: RR20 Balta RR23 Tamsiai pilka RR29 Tamsiai raudona RR32 Tamsiai ruda RR33 Juoda RR750 Plytų raudona

RR11 Tamsiai žalia\*\* RR21 Šviesiai pilka\*\* \*\*pagal užklausą

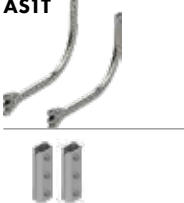
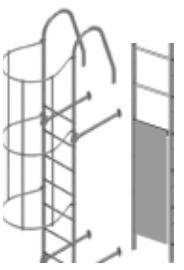
Nestandardinĕs spalvos +20 % (pagal užklausą), **Metalo blizgesio turinčios spalvos +30 %** (pagal užklausą)

PRODUKTAS		KODAS	PRISTATYMO LAIKAS	APIBŪDINIMAS	
	SIENINĖS KOPĖČIOS	1,2 m 			
	2,7 m 	+ SAS1		KOJELIŲ KIEKIS 4	
	3,3 m 				
	4,2 m 				
	5,4 m  	2 x 2,7 m	+ SAS1 + SAS1L	KOJELIŲ KIEKIS 6	
	6 m  	2,7 m + 3,3 m			
	6,6 m  	2 x 3,3 m			
	7,5 m  	3,3 m + 4,2 m	+ SAS1 + 2 x SAS1L	KOJELIŲ KIEKIS 8	
8,4 m  	2 x 4,2 m				
	AS1	85-100 cm 	SAS1	5	
	MONTAVIMO SERIJA AS1	20 cm 	SAS120	5	1 vnt / 3,6 m sieninės kopėčios
		25-40 cm 	SAS140	5	
		55-70 cm 	SAS170	5	
		115-130 cm 	SAS1130	5	
	SUJUNGIAMASIS ANTDEKLAS	20290	5		
	VIRŠUTINIAI LANKINIAI TURĖKLAI	20080	5		
U-FORMOS TVIRTINIMAS PRIE LAIPTŲ STOGO	20120	5			
L-FORMOS TVIRTINIMAS PRIE STOGO	20130	5			
KABĖS TVIRTINIMUI PRIE KARNIZO	20140	5			
	AS1L	85-100 cm 	SAS1L	5	
	PAPILDOMA SERIJA AS1L	20 cm 	SAS1L20	5	1 vnt / 3 m
		25-40 cm 	SAS1L40	5	
		55-70 cm 	SAS1L70	5	
		115-130 cm 	SAS1L130	5	
	AS1T	LANKINIŲ TURĖKLŲ ATRAMOS	SAS1T	5	
	VIRŠUTINĖ ATRAMA (VAMZD.)	20540	5		
	LANKINIŲ TURĖKLŲ ATRAMOS	35620	5		
	TVIRTINIMAS PRIE STOGO TILTELIO	20260	5		
	APATINIS LANKAS	AUKŠTIS 165 mm	20250	5	
	TVIRTINIMAS PAROC	20640	10		
	APSAUGA NUO ĮSILAUŽIMO	0,9 m 	20400	10	
		2,1 m 	20440	10	
	APSAUGINIS SIENOS KOPĖČIŲ ATITVARAS	24010	10		
	VERTIKALI PLOKŠTĖ 900 mm	24020	10		
	APSAUGOS REGIONO SUDĖTIS	35271	10		

# AVARINĖS KOPĖČIOS

PRODUKTAS	DIMENSIJA	APIBŪDINIMAS
	1,2 m	+ SAS8 KOJELIŲ KIEKIS 4
	2,7 m	
	3,3 m	+ SAS8 + SAS8L KOJELIŲ KIEKIS 6
	4,2 m	

PRODUKTAS	DIMENSIJA	KODAS	PRISTATYMO LAIKAS	APIBŪDINIMAS
	MONTAVIMO SERIJA <b>AS8</b>	SAS8	5	1 vnt / 3,0 m varinės kopėčios
	PAPILDOMA SERIJA <b>AS8L</b>	SAS8L	5	1 vnt / 3,0 m
	VIRŠUTINĖ AVARINIŲ KOPĖČIŲ ATRAMA	20160	5	
	VIRŠUTINĖS ATRAMOS TVIRTINIMAS	20500	5	
	ATRAMINĖ KOJA	20380	5	
	MONTAVIMO SERIJA <b>AS5U</b>	1,5 m	SAS5U	5
	PEREINAMOJO VAMZDELIO TVIRTINIMAS		20970	5
	PEREINAMASIS VAMZDELIS	1,5 m	20630	5

PRODUKTAS	KODAS	PRISTATYMO LAIKAS	KOPĖČIŲ ILGIS					
			5,4 m	6 m	6,6 m	7,5 m	8,4 m	
	1,2 m	21120	5					
	2,7 m	20040	5	2 vnt.	1 vnt.			
	3,3 m	21130	5		1 vnt.	2 vnt.	1 vnt.	
	4,2 m	20070	5				1 vnt.	2 vnt.
	PLASTMASINĖ SKLENDE OVALI.	20150	5					

\*Standartinės spalvos: **RR20 Balta** **RR23 Tamsiai pilka** **RR29 Tamsiai raudona** **RR32 Tamsiai ruda** **RR33 Juoda** **RR750 Plytų raudona**

**RR11 Tamsiai žalia\*\*** **RR21 Šviesiai pilka\*\*** \*\*pagal užklausą

Nestandartinės spalvos +20 % (pagal užklausą), **Metalo blizgesio turinčios spalvos +30 %** (pagal užklausą)

# LAIPTAI

PRODUKTAS	DIMENSJA	KODAS	PRISTATYMO LAIKAS	APIBŪDINIMAS
	LAIPTAI-PRIEBUTIS	1,2 m	22010	5
	LAIPTAI-PRIEBUTIS	2,4 m	22030	5
	LAIPTŲ-PRIEBUČIO ATITVARAS	2,4 m AUKŠTIS 0,6 m	SVR	10
	LAIPTŲ-PRIEBUČIO ATITVARO VIDURINĖ DALIS	2,5 m AUKŠTIS 0,6 m	SVRL	10

PRODUKTAS	KODAS	PRISTATYMO LAIKAS	APIBŪDINIMAS
-----------	-------	-------------------	--------------

## KR1 C2

	TVIRTINIMO KABĖ PRIE KRAIGO	20180	5	
				

## KR6 C2

	SUA-PAKYLA	20520	5	
	TVIRTINIMAS PROFKLOJINIO	34280	10	

## KR2 C2





	TVIRTINIMO PRIE UŽKAITO ELEMENTAS, Magnelis	22156	5	
				

	LAIPTELIS ANT NATŪRALIŲ ČERPIŲ	23090	10	
				<p>DĖMESIO! Šie gaminiai neženklinti CE ženklų</p> <p>50 x 50 mm</p>

\*Standartinės spalvos: RR23 Tamsiai pilka RR29 Tamsiai raudona RR32 Tamsiai ruda RR33 Juoda RR750 Plytų raudona

Nestandartinės spalvos +20 % (pagal užklausą), RR11 Tamsiai žalia\*\* RR20 Balta\*\* RR21 Šviesiai pilka\*\* \*\*pagal užklausą  
Metalo blizgesio turinčios spalvos +30 % (pagal užklausą)

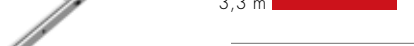
# STOGO KOPĒČIOS

PRODUKTAS	KODAS	PRISTATĪVĀMO LAIKAS	KOPĒČIŅU ILGIJS				
			5,4 m	6 m	6,6 m	7,5 m	8,4 m
<b>KOPĒČIŅU MODULĪI</b>							
 1,2 m	21120	5					
 2,7 m	20040	5	2 vnt.	1 vnt.			
 3,3 m	21130	5		1 vnt.	2 vnt.	1 vnt.	
 4,2 m	20070	5				1 vnt.	2 vnt.
 PLASTMASINĒ SKLENĒĒ OVĀLĪ.	20150	5					

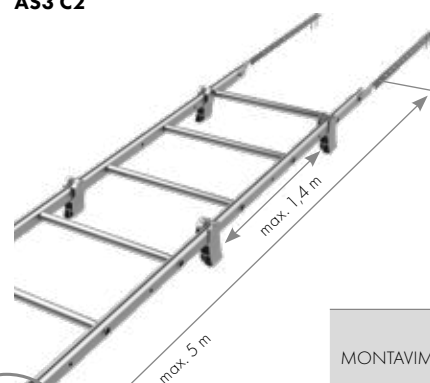
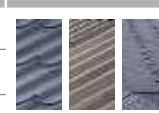
PRODUKTAS	DIMENSĪJA	KODAS	PRISTATĪVĀMO LAIKAS	APIBŪDINĪMĀS
 max. 1,4 m max. 5 m	3,3 m	+ SAS3C2		 <b>CEc2</b>
	4,2 m	+ SAS3C2		
	5,4 m 2,7 m + 2,7 m	+ SAS3C2		
	6,0 m 2,7 m + 3,3 m	+ SAS3C2 + SAS3L		
	6,6 m 3,3 m + 3,3 m	+ SAS3C2 + SAS3L		
	7,5 m 3,3 m + 4,2 m	+ SAS3C2 + SAS3L		
MONTAVĪMO SERĪJA <b>AS3C2</b>	SAS3C2	5	2 x TVIRTINĪMO KABĒ PRIE KRAIGO + 10 x PLASTMASINĒ KOJA 1 vnt SAS3C2 / 6 m	
MONTAVĪMO SERĪJA <b>AS3L</b>	SAS3L	5	2 x METALINĒ KOJA ANT STOGO	
PLASTMASINĒ KOJA	20240	5		
TVIRTINĪMO KABĒ PRIE KRAIGO	20180	5		
METALINĒ KOJA ANT STOGO	20320	5		

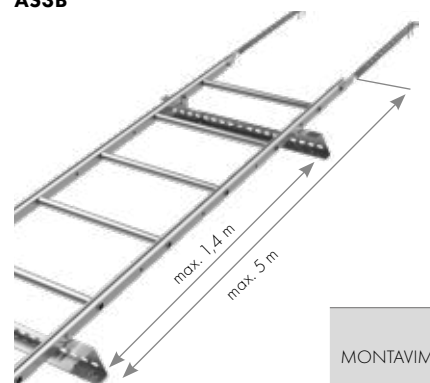
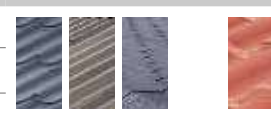
PRODUKTAS	DIMENSĪJA	KODAS	PRISTATĪVĀMO LAIKAS	APIBŪDINĪMĀS
 max. 1,4 m max. 5 m	3,3 m	+ SAS3B		 <b>CEc2</b>
	4,2 m	+ SAS3B		
	5,4 m 2,7 m + 2,7 m	+ SAS3B + SAS3BL		
	6,0 m 2,7 m + 3,3 m	+ SAS3B + SAS3BL		
	6,6 m 3,3 m + 3,3 m	+ SAS3B + 2 x SAS3BL		
	7,5 m 3,3 m + 4,2 m	+ SAS3B + 3 x SAS3BL		
MONTAVĪMO SERĪJA <b>AS3B</b>	SAS3B	5	4 x SIJA-PAKYLA + 2 TVIRTINĪMO KABĒ PRIE KRAIGO 1 vnt SAS3B / 4,2 m	
MONTAVĪMO SERĪJA <b>AS3B</b> PĀPILDOMA	SAS3BL	5	1 x SIJA-PAKYLA 1 vnt SAS3B / 3 m	
SIJA-PAKYLA	20520	5		
TVIRTINĪMO KABĒ PRIE KRAIGO	20180	5		

\*StandartinĒs spalvas: **RR23 Tamsiā pilka** **RR29 Tamsiā raudona** **RR32 Tamsiā ruda** **RR33 Juoda** **RR750 Plytū raudona**

**RR11 Tamsiā žalia\*\*** **RR20 Balta\*\*** **RR21 Šviesiā pilka\*\*** \*\*pagal ūzklausā

**NestandardinĒs spalvas +20 %** (pagal ūzklausā), **Metalo blizgesio turinĒios spalvas +30 %** (pagal ūzklausā)

PRODUKTAS	DIMENSIJA	KODAS	PRISTATYMO LAIKAS	APIBŪDINIMAS
<b>AS2 C2</b> 	3,3 m	+ SAS2C2		 <b>CEc2</b>
	4,2 m	+ SAS2C2		
	5,4 m 2,7 m + 2,7 m	+ SAS2C2		
	6,0 m 2,7 m + 3,3 m	+ SAS2C2 + SAS2LC2		
	6,6 m 3,3 m + 3,3 m	+ SAS2C2 + SAS2LC2		
	7,5 m 3,3 m + 4,2 m	+ SAS2C2 + SAS2LC2		
MONTĀŽAS KOMPLEKTS UZ FALCES <b>AS2 C2</b>	SAS2C2	5	2 x TVIRTINIMO PRIE UŽKAITO ELEMENTAS + 8 x PLASTMASINĖ KOJA 1 vnt. SAS2C2 / 5,1 m	
MONTĀŽAS KOMPLEKTS UZ FALCES <b>AS2LC2</b> PAPILD.	SAS2LC2	5	1 x TVIRTINIMO PRIE UŽKAITO ELEMENTAS + 4 PLASTMASINĖ KOJA 1 vnt. AS2LC2 / 5 m	
TVIRTINIMO PRIE UŽKAITO ELEMENTAS	22440	5	C2	
TVIRTINIMAS - KILPA	20420	5		
PLASTMASINĖ KOJA	20240	5		

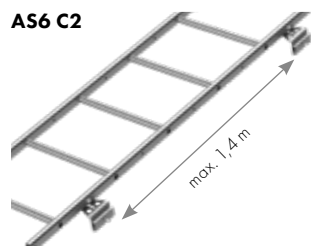
**AS6 C2**

**TVIRTINIMO PRIE UŽKAITO ELEMENTAS AS6 C2**

22060

5

**CEc2**

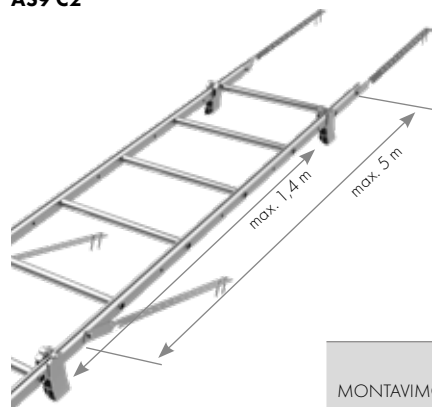
540 mm

**AS9 C2**

3,3 m + SAS9C2

4,2 m + SAS9C2

5,4 m  
2,7 m + 2,7 m + 2 x SAS9C26,0 m  
2,7 m + 3,3 m + 2 x SAS9C26,6 m  
3,3 m + 3,3 m + 2 x SAS9C27,5 m  
3,3 m + 4,2 m + 2 x SAS9C2
**CEc2**
MONTAVIMO SERIJA **AS9**

SAS9C2

5

4 x TVIRTINIMO KABĖ PRIE KRAIGO + 10 PLASTMASINĖ KOJA

1 vnt. SAS9C2 / 5,1 m

PLASTMASINĖ KOJA

20240

5





TVIRTINIMO KABĖ PRIE KRAIGO

20180

5

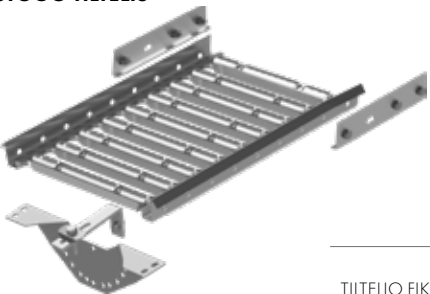
# STOGO TILTELIAI



PRODUKTAS	KODAS	PRISTATYMO LAIKAS	APIBŪDINIMAS
<b>STOGO TILTĖLIS</b>			
 0,60 m 	30640	10	Plotis 350 mm
1,21 m 	30010	5	
2,25 m 	30200	5	
2,97 m 	30030	5	
TILTĖLIO FIKSATORIUS	30060	5	Plotis 350 mm
JUNGIAMOJI PLOKŠTELĖ	30040	5	1 vnt.
TOLTĖLIO KRAŠTO ATRAMA	35110	5	



TILTĖLIO ATITVARAS	1,2 m 	35140	10
--------------------	---	-------	----

**SVL**

TILTĖLIO STOGO ATITVARAS	3,0 m 	SVL	10
--------------------------	---	-----	----











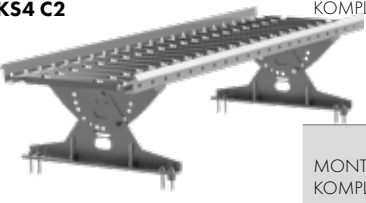

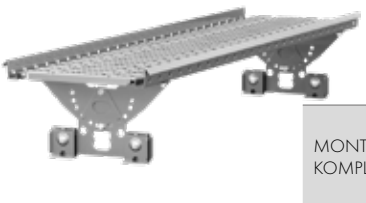
GALINIS ATITVARO LANKAS		35130	10
-------------------------	--	-------	----

\*Standartinės spalvos: **RR23 Tamsiai pilka** **RR29 Tamsiai raudona** **RR32 Tamsiai ruda** **RR33 Juoda** **RR750 Plytų raudona**

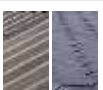
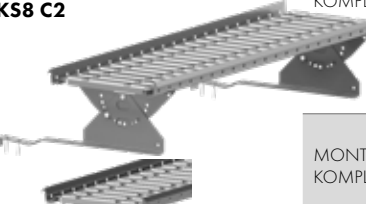
**RR11 Tamsiai žalia\*\*** **RR20 Balta\*\*** **RR21 Šviesiai pilka\*\*** \*\*pagal užklausą

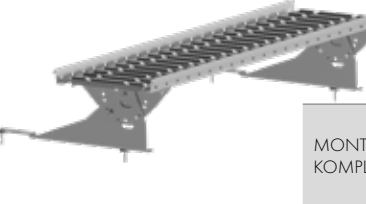
**Nestandartinės spalvos +20 %** (pagal užklausą), **Metalo blizgesio turinčios spalvos +30 %** (pagal užklausą)



PRODUKTAS	DIMENSIJA	KODAS	PRISTATYMO LAIKAS	APIBŪDINIMAS	
<b>KS4 C2</b> 	KOMPLEKTAI	0,6 m*	STTJRC2	10	
		1,21 m	STTOC2	5	
		2,25 m	STTNC2	5	
		2,97 m	STTFC2	5	
	MONTAVIMO KOMPLEKTAI	0,6 m*	STTJRZC2	5	
		1,21 m/2,25 m	STTNZC2	5	
		2,97 m	STTFZC2	5	
	TVIRTINIMAS PRIE STOGO		30630	5	1,2 m
					
					<b>CEc2</b>
<b>KS3 (C1)</b> 	KOMPLEKTAI	0,6 m	STTJO	10	
		1,21 m	STTL	5	
		2,25 m	STTG	5	
		2,97 m	STTA	5	
	MONTAVIMO KOMPLEKTAI	0,6 m/1,21 m	STTLZ	5	
		2,25 m	STTGZ	5	
		2,97 m	STTAZ	5	
	KOMPLEKTAS TVIRTINIMUI PRIE UŽKAITO		35640	5	1,2 m
					
					<b>CEc1</b>
<b>KS3 C2</b> 	KOMPLEKTAI	0,6 m*	STTJOC2	10	
		1,21 m	STTLC2	5	
		2,25 m	STTGC2	5	
		2,97 m	STTAC2	5	
	MONTAVIMO KOMPLEKTAI	0,6 m*	STTJOZC2	5	
		1,21 m/2,25 m	STTGZC2	5	
		2,97 m	STTAZC2	5	
	KOMPLEKTAS TVIRTINIMUI PRIE UŽKAITO C2		35820	5	1,2 m
					
					<b>CEc2</b>
<b>KS7 C2</b> 	KOMPLEKTAI	0,6 m*	STTJS	10	
		1,21 m	STTDBC2	5	
		2,25 m	STTDA	5	
		2,97 m	STTD	5	
	MONTAVIMO KOMPLEKTAI	0,6 m*	STTJSZ	5	
		1,21 m/2,25 m	STTDAZ	5	
		2,97 m	STTDZ	5	
	TVIRTINIMAS PRIE PROFILIO		30530	5	1,2 m
					
					<b>CEc2</b>
<b>KS8 C2</b> 	KOMPLEKTAI	0,6 m*	STTJ	10	
		1,21 m	STTIC2	5	
		2,25 m	STTH	5	
		2,97 m	STTC	5	
	MONTAVIMO KOMPLEKTAI	0,6 m*	STTJZ	5	
		1,21 m/2,25 m	STTHZ	5	
		2,97 m	STTCZ	5	
	TVIRTINIMAS ANT ČERPĒMS		31050	5	1,2 m, 50 x 100 mm
	TVIRTINIMAS BIBER		31590	10	1,2 m, 50 x 100 mm
	TVIRTINIMO PRIE NAT. ČERPIŅU ATRAMA		31680	10	1,2 m, 50 x 100 mm
PLOKŠTELĒ PO ATRAMA		31690	10	1,2 m, 32 x 100 mm	
<b>KS8D C2</b>					
TVIRTINIMAS ANT ČERPĒMS		30820	10	32 x 100 mm	
32 x 100 mm		30830	10		
					
				<b>CEc2</b>	
<b>KS ET</b> 	KOMPLEKTAI	0,6 m	STTETA	10	
		1,21 m	STTETB	10	
		2,25 m	STTETC	10	
		2,97 m	STTET	10	
	MONTAVIMO KOMPLEKTAI	0,6 m/1,21 m	STTETBZ	10	
		2,25 m	STTETCZ	10	
		2,97 m	STTETZ	10	
	TVIRTINIMAS PRIE ETERNIT		31870	10	1,2 m
					
					ETERNIT 920 x 585 mm min. 50 x 50 mm
<b>KS CEM</b> 	KOMPLEKTAI	0,6 m	STTCEMA	10	
		1,21 m	STTCEMB	10	
		2,25 m	STTCEMC	10	
		2,97 m	STTCEM	10	
	MONTAVIMO KOMPLEKTAI	0,6 m/1,21 m	STTCEMBZ	10	
		2,25 m	STTCEMCZ	10	
		2,97 m	STTCEMZ	10	
	TVIRTINIMAS PRIE CEMBRIT		31850	10	1,2 m
					
					CEMBRIT 625 mm

\*CE apstiprinātām 2. klases iekārtām (ko izmanto kā piespīrināšanās vietu, lai persona izsargātos no kritieniem) vienmēr izmantojiet vismaz trīs stiprinājumus!

# SNIEGO SULAIKYMAS



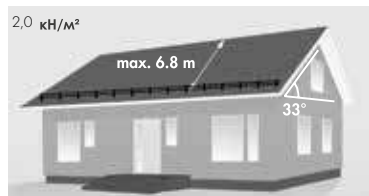

## SNIEGO SULAIKYMO EILIŲ APSKAIČIAVIMO LENTELĖ

Pavyzdys: Stogo nuolydis 1:3 = 18°, sniego apkrova 2 kN/m<sup>2</sup>, maksimalus šlaito ilgis vieni sniego sulaikyimo eilei 6,8 m.





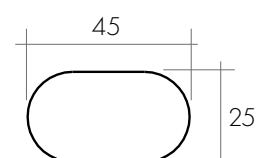











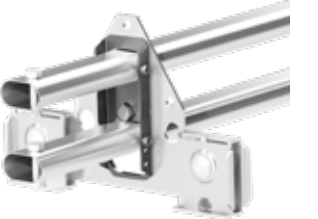

















Stogo nuolydis			SNIEGO APKROVA kN/m <sup>2</sup> (~ 100 kg/m <sup>2</sup> )					
			1	1,5	2	2,5	3	3,5
6°	~1:10	▲	60 m	40 m	30 m	24 m	20 m	17 m
10°	~1:5	▲	37 m	24 m	18 m	15 m	12 m	10 m
14°	1:4	▲	27 m	18 m	13 m	11 m	8,9 m	7,6 m
18°	1:3	▲	21 m	14 m	11 m	8,5 m	7,1 m	6,1 m
23°	~1:2,5	▲	17 m	12 m	8,7 m	7,0 m	5,8 m	5,0 m
27°	1:2	▲	15 m	10 m	7,7 m	6,2 m	5,2 m	4,4 m
33°	1:1,5	▲	14 m	9,1 m	6,8 m	5,5 m	4,6 m	3,9 m
38°		▲	13 m	8,6 m	6,4 m	5,2 m	4,3 m	3,7 m
42°		▲	13 m	8,4 m	6,3 m	5,0 m	4,2 m	3,6 m
45°	1:1	▲	13 m	8,3 m	6,3 m	5,0 m	4,2 m	3,6 m
50°		▲	13 m	8,5 m	6,3 m	5,1 m	4,2 m	3,6 m
55°		▲	13 m	8,9 m	6,7 m	5,3 m	4,4 m	3,8 m
60°		▲	14 m	9,6 m	7,2 m	5,8 m	4,8 m	4,1 m

PRODUKTAS	DIMENSIJA	KODAS	PRISTATYMO LAIKAS	APIBŪDINIMAS
	OVALUS VAMZDELIS 3 m 	31010	5	

\*Standartinės spalvos: **RR23 Tamsiai pilka** **RR29 Tamsiai raudona** **RR32 Tamsiai ruda** **RR33 Juoda** **RR750 Plytų raudona**

**RR11 Tamsiai žalia\*\*** **RR20 Balta\*\*** **RR21 Šviesiai pilka\*\*** \*\*pagal užklausą

**Nestandartinės spalvos +20 %** (pagal užklausą), **Metalo blizgesio turinčios spalvos +30 %** (pagal užklausą)

	PRODUKTI	KODS	PIEGĀDES LAIKS		APRAKSTS
<b>LE3</b> 	KOMPLEKTAI 3 m 	SLEK	5		
	MONTAVIMO KOMPLEKTAI 3 m 	SLEKZ	5		
	STIPRINĀJUMS PIE JUMTA	30630	5		1,2 m
<b>LE2</b>   	KOMPLEKTAI 3 m 	SLEA	5		
	MONTAVIMO KOMPLEKTAI 3 m 	SLEAZ	5		
	KOMPLEKTAS TVIRTINIMUI PRIE UŽKAITO	35640	5		1,2 m
	VAMZDELIŅ KRAŠTO ATRAMA	31800	10		TVirtinimui 35640
	SNIEGO SULAİKYO VAMZDELIO 500 mm 	31560	10		Jungtinis stogas
	SNIEGO SULAİKYO VAMZDELIO 964 mm 	31580	10		
	SNIEGO SULAİKYO VAMZDELIO 441 mm 	31810	10		
SNIEGO SULAİKYO VAMZDELIO 920 mm 	31820	10		Weckman Proganti	
<b>LE6</b> 	KOMPLEKTAI 3 m 	SLEE	5		
	MONTAVIMO KOMPLEKTAI 3 m 	SLEEZ	5		
	TVIRTINIMAS PRIE PROFILIO	30530	5		1,2 m
<b>LE8</b>  	KOMPLEKTAI 3 m 	SLED	5		
	MONTAVIMO KOMPLEKTAI 3 m 	SLEDZ	5	50 x 100	
	TVIRTINIMAS ANT. ČERPĒMS	31050	5		1,2 m
	TVIRTINIMAS BIBER	31590	10		1,2 m
SNIEGO SULAİKYO VAMZDELIO 928 mm 	31830	10		Natūralios čerpės Ormax	
<b>LE8D</b> 	TVIRTINIMAS ANT. ČERPĒMS <b>LE8D</b>	30820	10		1,2 m
	32x100 mm	30830	10		32 x 100
<b>LE ET</b> 	KOMPLEKTAI 3 m 	SLET	10		
	MONTAVIMO KOMPLEKTAI 3 m 	SLETZ	10	ETERNIT 920 x 585 mm 50 x 50 mm	
	TVIRTINIMAS PRIE ETERNIT	31870	10		1,2 m
<b>LE CEM</b> 	KOMPLEKTAI 3 m 	SLEN	10		
	MONTAVIMO KOMPLEKTAI 3 m 	SLENZ	10	CEMBRIT 625 mm	
	TVIRTINIMAS PRIE CEMBRIT	31850	10		1,2 m

# GROTŲ SNIEGO SULAIKYMAS



Sniego sulaikymo eilių apskaičiavimo lentelė psl. 18

PRODUKTAS	DIMENSIJA	KODAS	PRISTATYMO LAIKAS	APIBŪDINIMAS
<b>GROTŲ SNIEGO SULAIKYMAS</b> 	SNIEGO SULAIKYMO GROTELĖS	1,23 m	32010	10
		2,46 m	32020	5
	JUNGIAMOJI PLOKŠTELĖ		32030	5
	JGILINTOS GROTELĖS	2,46 m	32190	5
	GROTELIŲ TVIRTINIMO ELEMENTAS		32140	5
	GROTELIŲ TVIRTINIMO KOMPLEKTAS		35330	5

PRODUKTAS	DIMENSIJA	KODAS	PRISTATYMO LAIKAS	APIBŪDINIMAS
<b>VLE3</b> 	MONTAVIMO KOMPLEKTAI <b>VLE3</b>	2,46 m	SLVZ	5
	TVIRTINIMAS PRIE STOGO		30630	5
<b>VLE2</b> 	MONTAVIMO KOMPLEKTAI <b>VLE2</b>	2,46 m	SLVAZ	5
<b>VLE2H</b> 	MONTAVIMO KOMPLEKTAI <b>VLE2H</b>	2,46 m	SLVCZ	5
	KOMPLEKTAS TVIRTINIMUI PRIE UŽKAITO		35640	5
<b>VLE5</b> 	MONTAVIMO KOMPLEKTAI <b>VLE5</b>	2,46 m	SLVEZ	5
	TVIRTINIMAS PRIE PROFILIO		30530	5
<b>VLE8</b> 	MONTAVIMO KOMPLEKTAI <b>VLE8</b>	2,46 m	SLVPZ	5
	TVIRTINIMAS ANT ČERPĖMS		31050	5
	TVIRTINIMAS BIBER		31590	10

\*Standartinės spalvos: **RR23 Tamsiai pilka** **RR29 Tamsiai raudona** **RR32 Tamsiai ruda** **RR33 Juoda** **RR750 Plytų raudona**

**RR11 Tamsiai žalia\*\*** **RR20 Balta\*\*** **RR21 Šviesiai pilka\*\*** \*\*pagal užklausą

**Nestandartinės spalvos +20 %** (pagal užklausą), **Metalo blizgesio turinčios spalvos +30 %** (pagal užklausą)





# STOGO ATITVARAI

PRODUKTAS	DIMENSIJA	KODAS	PRISTATYMO LAIKAS	APIBŪDINIMAS
<b>SYP</b> 	KOMPLEKTAI ILGIS 3 m AUKŠTIS 0,6 m	 SYP	10	
<b>SYV</b> 	KOMPLEKTAI ILGIS 3 m AUKŠTIS 0,6 m	 SYV SYVL	10 10	
<b>SYO</b> 	KOMPLEKTAI SU SNIEGO SULAIKYMU ILGIS 3 m AUKŠTIS 1,1 m	 SYO SYOL	10 10	
<b>SYT</b> 	KOMPLEKTAI ILGIS 3 m AUKŠTIS 0,6 m	 SYT SYTL	10 10	
<b>SYS</b> 	KOMPLEKTAI SU SNIEGO SULAIKYMU ILGIS 3 m AUKŠTIS 1,1 m	 SYS SYSL	10 10	
<b>SYR</b> 	KOMPLEKTAI ILGIS 3 m AUKŠTIS 0,6 m	 SYR SYRL	10 10	
<b>SYN</b> 	KOMPLEKTAI SU SNIEGO SULAIKYMU ILGIS 3 m AUKŠTIS 1,1 m	 SYN SYNL	10 10	

\*Standartinės spalvos: RR23 Tamsiai pilka RR29 Tamsiai raudona RR32 Tamsiai ruda RR33 Juoda RR750 Plytų raudona

RR11 Tamsiai žalia\*\* RR20 Balta\*\* RR21 Šviesiai pilka\*\* \*\*pagal užklausą  
 Nestandartinės spalvos +20% (pagal užklausą), Metalo blizgesio turinčios spalvos +30% (pagal užklausą)





PRODUKTAS	DIMENSIJA	KODAS	PRISTATĀMO LAIKAS	APIBŪDINĪMAS
	BĒGIS 3,0 m	33800	5	Vienas modelis vertikālam ir horizontālam naudojumui.
	JUNGJAMOJI PLOKŠTELĒ	33840	5	Lengvas ir tvirtas bēgis.

PRODUKTAS	DIMENSIJA	KODAS	PRISTATĀMO LAIKAS	APIBŪDINĪMAS		
	VERTIKALAUS BĒGIO RATUKAI, nerūd. plienas		33880	5	Vartotojo svoris, atsižvelgiant į santykį: 40–160 kg Atstums tarp vartotojų: ne mažiau, kaip 6 metrai <b>CE</b>	
	LANKAS 2,6 M IŠĒJIMUI ANT STOGO		2,6 m	33870	5	
	BĒGIS KOMPLEKTAI ŠONINIS IŠĒITIS		1 m	33780	10	
	RITINIS TVIRTINĪMAS, nerūd. plienas			33860	5	Tvirtinti kas 1,5 m
	APSAUGA NUO ĮSILAUŽIMO 2,1 M			2,1 m	20340	10
	VERTIKALAUS BĒGIO SISTEMOS ŽENKLINĪMAS		33900	5		

\*Standartinės spalvos: **RR23 Tamsiai pilka** **RR29 Tamsiai raudona** **RR32 Tamsiai ruda** **RR33 Juoda** **RR750 Plytų raudona**

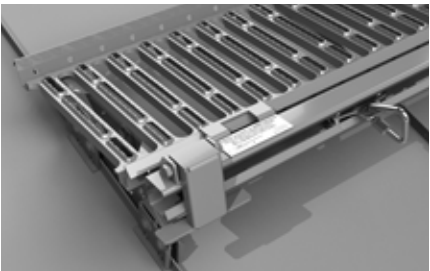
**RR11 Tamsiai žalia\*\*** **RR20 Balta\*\*** **RR21 Šviesiai pilka\*\*** \*\*pagal užklausą

**Nestandartinės spalvos +20 %** (pagal užklausą), **Metalo blizgesio turinčios spalvos +30 %** (pagal užklausą)

PRODUKTAS	KODAS	PRISTATYMO LAIKAS	APIBŪDINIMAS
<b>HORIZONTALAUS BĖGIO</b> 	HORIZONTALAUS BĖGIO RATUKAI, nerūd. plienas 	33850	5
			Vartotojo svoris, įskaitant įrangą: ne daugiau, kaip 120 kg. Atstumas tarp vartotojų: ne mažiau, kaip 3 metrai.
	HOR. BĖGIO MONTAVIMO PRIE TILTELIO RINKINYS 33890	5	
	HORIZONTALIŲ RATUKŲ BLOKAVIMO ĮRENGINYS, ATIDAROMAS 33810	5	
	HORIZONTALIŲ RATUKŲ BLOKAVIMO ĮRENGINYS, NEATIDAROMAS 33820	5	
	HORIZONTALAUS BĖGIO TVIRTINIMAS PRIE SIENOS 33830	5	Tvirtinti kas 2,0 m
	HORIZONTALAUS BĖGIO SISTEMOS ŽENKLINIMAS 33910	5	

PRODUKTAS	DIMENSIJA	KODAS	PRISTATYMO LAIKAS	APIBŪDINIMAS
	KOMPLEKTAI 3 m 	PHK3016	10	1 x BĖGIS 3 m + 4 x TVIRTINIMAI 
	KOMPLEKTAI 1 TVIRTINTI 1 vnt. 	PHKL16	10	1,2 m
	KOMPLEKTAI 3 m 	PHK3013	10	1 x BĖGIS 3 m + 4 x TVIRTINIMAI 
	KOMPLEKTAI 1 TVIRTINTI 1 vnt. 	PHKL13	10	1,2 m
	KOMPLEKTAI 3 m 	PHK3014	10	1 x BĖGIS 3 m + 4 x TVIRTINIMAI 
	KOMPLEKTAI 1 TVIRTINTI 1 vnt. 	PHKL14	10	1,2 m
	KOMPLEKTAI 3 m 	PHK3012	10	1 x BĖGIS 3 m + 4 x TVIRTINIMAI 
	KOMPLEKTAI 1 TVIRTINTI 1 vnt. 	PHKL12	10	1,2 m
	KOMPLEKTAI 3 m 	PHK3015	10	1 x BĖGIS 3 m + 4 x TVIRTINIMAI 
	KOMPLEKTAI 1 TVIRTINTI 1 vnt. 	PHKL15	10	1,2 m

## SNIEGO SULAIKYMAS



**LE3**

METALO ČERPĖS IR MINKŠTAS STOGAS



**LE2**

JUNGTINIS STOGAS



**LE6**

PROFKLOJINYS IR MINKŠTAS STOGAS



**LE8**

NATŪRALIOS ČERPĖS

## GROTŲ SNIEGO SULAIKYMAS

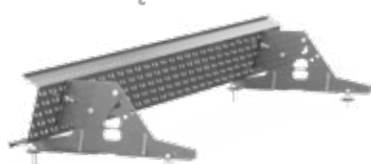

**VLE3**

METALO ČERPĖS IR MINKŠTAS STOGAS



**VLE2H**

JUNGTINIS STOGAS

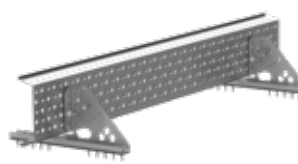

**VLE5**

PROFKLOJINYS IR MINKŠTAS STOGAS



**VLE8**

NATŪRALIOS ČERPĖS

## STOGO TILTĖLIAI



**KS4C2**

METALO ČERPĖS IR MINKŠTAS STOGAS



**KS3C2**

JUNGTINIS STOGAS



**KS7C2**

PROFKLOJINYS IR MINKŠTAS STOGAS



**KS8C2**

NATŪRALIOS ČERPĖS

## STOGO ATITVARAI



**SYOL**

METALO ČERPĖS IR MINKŠTAS STOGAS



**SYN**

JUNGTINIS STOGAS



**SYT**

PROFKLOJINYS IR MINKŠTAS STOGAS



**SYRL**

JUNGTINIS STOGAS